

MSC-E1 Series

40 W AC/DC Switching Power Supply Module – Medical

CoolPower
Solutions

- Switching Power Modules for PCB Mounting
- Fully Encapsulated Plastic Case
- Universal Input Range 90-264VAC, 47-440 Hz
- Regulated Output
- Low Ripple and Noise
- High Efficiency
- CE, CB, UL, cUL, TUV Approvals
- 3-Years Product Warranty



Electrical specifications

Model No. (Single Output)	MSC-3.3S-E1	MSC-5S-E1	MSC-9S-E1	MSC-12S-E1	MSC-15S-E1	MSC-24S-E1	
Max Output Wattage (W)	26.4W	40W	40W	40W	40W	40W	
Output	Voltage (VDC)	3.3V	5V	9V	12V	15V	24V
	Current (mA) max.	8000	8000	4444	3333	2666	1667
	Voltage set accuracy	±2%	±2%	±2%	±2%	±2%	±2%
	Line regulation (Typ.)	0.5%	0.5%	0.5%	0.5%	0.5%	0.5%
	Load regulation (0-100%) (Typ.)	1%	1%	1%	1%	1%	1%
	Minimum load	1%	1%	1%	1%	1%	1%
	Efficiency (Typ)	75%	79%	82%	83%	83%	83%

Model No. (Dual Output)	MSC-5D-E1		MSC-12D-E1		MSC-15D-E1		
Max Output Wattage (W)	40W		40W		40W		
Output	Output 1	Output 2	Output 1	Output 2	Output 1	Output 2	
	Voltage (VDC)	+5V	-5V	+12V	-12V	+15V	-15V
	Current (mA) max.	4000	4000	1666	1666	1333	1333
	Voltage set accuracy	±2%		±2%		±2%	
	Line regulation (Typ.)	0.5%		0.5%		0.5%	
	Load regulation (0-100%) (Typ.)	1% (symmetric load)		1% (symmetric load)		1% (symmetric load)	
	Cross regulation	5%		5%		5%	
	Minimum load	10%		10%		10%	
Efficiency (Typ)	79%		83%		83%		

Model No. (Dual Output)	MTC-5S12S-E1		MTC-5S24S-E1		
Max Output Wattage (W)	40W		40W		
Output	Output 1	Output 2	Output 1	Output 2	
	Voltage (VDC)	+5V	+12V	+5V	+24V
	Current (mA) max.	5000	1250	5000	625
	Voltage set accuracy	±3%	±5%	±3%	±5%
	Line regulation (Typ.)	0.5%	5%	0.5%	5%
	Load regulation (0-100%) (Typ.)	2% (symmetric load)	6% (symmetric load)	2% (symmetric load)	6% (symmetric load)
	Cross regulation (Typ)	1%	7%	1%	7%
	Minimum load	25%		25%	
Efficiency (Typ)	80%		80%		

MSC-E1 Series

40 W AC/DC Switching Power Supply Module – Medical

CoolPower
Solutions

Model No. (Triple Output)	MTC-5S12D-E1			MTC-5S15D-E1			
Max Output Wattage (W)	40W			40W			
Output		Output 1	Output 2	Output 3	Output 1	Output 2	Output 3
	Voltage (VDC)	+5V	+12V	-12V	+5V	+15V	-15V
	Current (mA) max.	5000	600	600	5000	500	500
	Voltage set accuracy	±3%	±5%		±3%	±5%	
	Line regulation (Typ.)	0.5%	5%		0.5%	5%	
	Load regulation (0-100%) (typ.)	3%	7% (symmetric load)		3%	7% (symmetric load)	
	Cross regulation (Typ)	3%	7%		3%	7%	
	Minimum load	25%			25%		
Efficiency (Typ)	80%			80%			

Input	Voltage	90-264 VAC or 100-375 VDC
	Frequency (Hz)	47-440 Hz
	Current (Full load)	860 mA max. (115 VAC) / 460 mA max. (230 VAC)
	Inrush Current (<2ms)	23 A max. (115 VAC) / 46 A max. (230 VAC)
	Leakage Current	0.1 mA max. (115 VAC) / 0.2 mA max. (230 VAC).
	External fuse (recommend)	3.15 A slow blow type
Output	Maximum Capacitive Load	470-23,000µF depending on model
	Ripple & Noise (Vp-p)	3.3V: 50mV , 5V-24V: 1% of Vout
	Hold-up Time	18 ms min.
	Switching Frequency	132 kHz
Protection	Over Current Protection	Above 105% rated output power
	Over Voltage Protection	Zener diode clamp
	Short Circuit Protection	Hiccup mode, indefinite (automatic recovery)
	OTP	100°C
Isolation	Input-Output (V.AC)	4000V
Environment	Operating Temperature	-40°C...+70°C (Case Temperature max. +95°C)
	Storage Temperature	-40°C...+100°C
	Temperature Coefficient	±0.01%/°C
	Humidity	95% RH
	MTBF	200,000 – 400,000 h @ 25°C
Physical	Dimension (L x W x H)	3.5 x 2.5 x 1.06 Inches (89.0 x 63.5 x 27.0 mm) Tolerance ±0.5 mm
	Case Material	Plastic resin + Fiberglass (flammability to UL 94V-0)
	Weight	280 g
	Cooling Method	Free air convection
Safety & EMC	Class II	To IEC / EN 60536
	Safety Approvals	EN60601-1
	approval	cUL / UL / CB
	EMI / PFI conducted	EN 55011 class B
	EMC Standards	EN60601-1-2
	ESD Susceptibility	EN60601-1-2
	Radiated Susceptibility	EN60601-1-2
	EFT / Burst	EN60601-1-2
	Surge	EN60601-1-2
Conducted Susceptibility	EN60601-1-2	

All specifications valid at nominal input voltage, full load and +25°C after warm-up time unless otherwise stated.

MSC-E1 Series

40 W AC/DC Switching Power Supply Module – Medical

CoolPower
Solutions

Mechanical Specifications (top view)

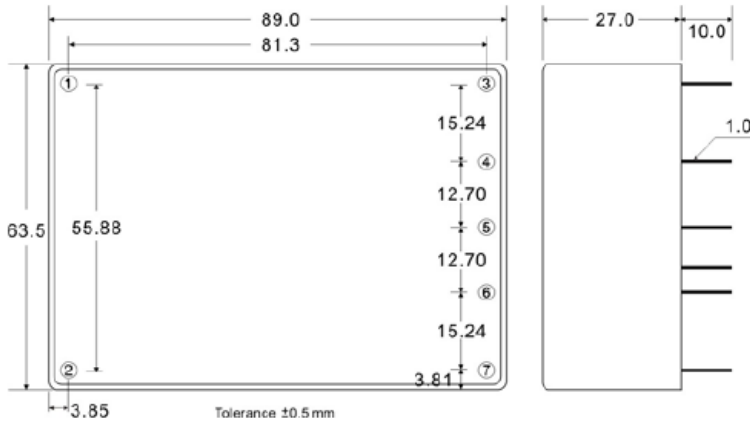

Pin	Single	Dual	5S/12S 5S24S	Triple
1	AC IN (L)	AC IN (L)	AC IN (L)	AC IN (L)
2	AC IN (N)	AC IN (N)	AC IN (N)	AC IN (N)
3	+DC OUT	+DC OUT	+OUT 2	+DC OUT
4	NO PIN	NO PIN	+OUT 1	+5 V
5	-DC OUT	COMMON	+OUT 2 RTN	COMMON
6	NO PIN	NO PIN	+OUT 1 RTN	+5 V RTN
7	NO CONN	-DC OUT	NO PIN	-DC OUT

BLOCK DIAGRAM

Single Output

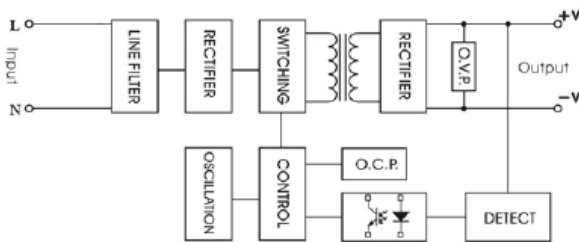

DERATING

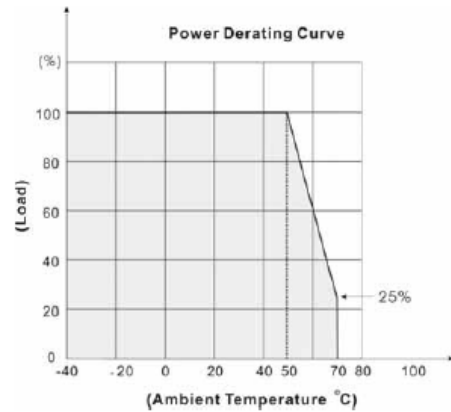

Dual Output

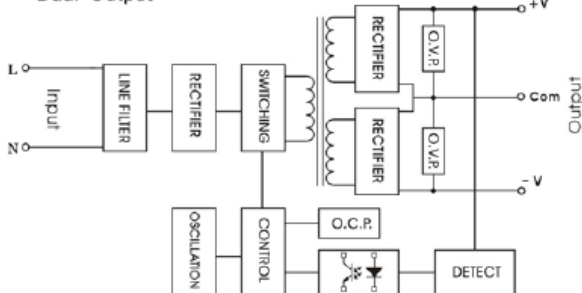

Triple Output

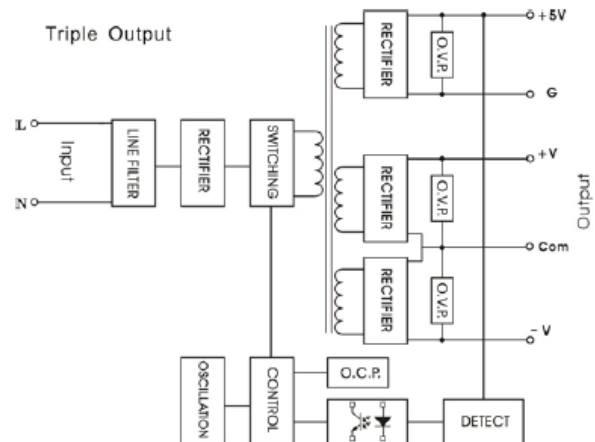

MSC-E1 Series

40 W AC/DC Switching Power Supply Module – Medical

CoolPower
Solutions

SCREW TERMINALS

MSC-E1-A2

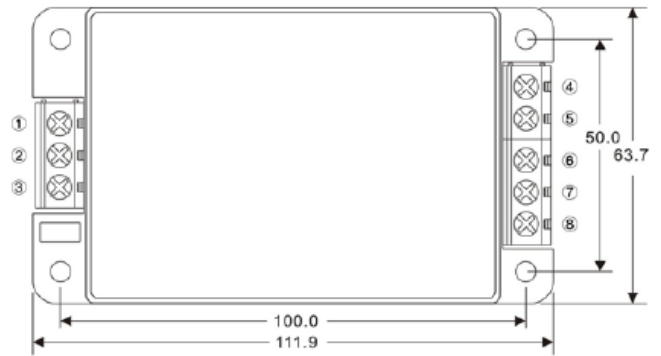

Pin	Single	Dual	5S/12S 5S24S	Triple
1	NO CONN	NO CONN	NO CONN	NO CONN
2	AC IN (L)	AC IN (L)	AC IN (L)	AC IN (L)
3	AC IN (N)	AC IN (N)	AC IN (N)	AC IN (N)
4	+DC OUT	+DC OUT	+OUT 2	+DC OUT
5	NO CONN	NO CONN	+OUT 1	+5V OUT
6	-DC OUT	COMMON	+OUT 2 RTN	COMMON
7	NO CONN	NO CONN	+OUT 1 RTN	+5V RTN
8	NO CONN	-DC OUT	NO CONN	-DC OUT

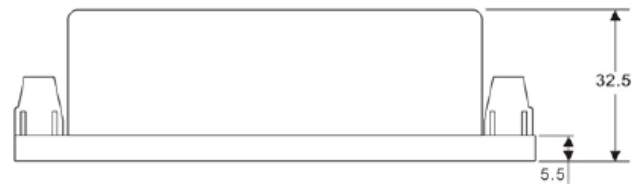

CoolPower
Solutions

MSC-E1-A3

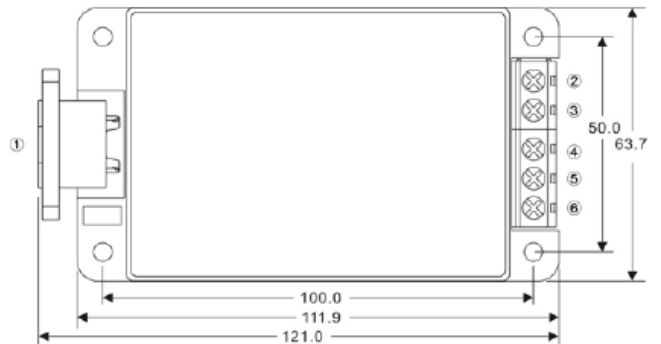

Pin	Single	Dual	5S/12S 5S24S	Triple
1	AC IN	AC IN	AC IN	AC IN
2	+DC OUT	+DC OUT	+OUT 2	+DC OUT
3	NO CONN	NO CONN	+OUT 1	+5V OUT
4	-DC OUT	COMMON	+OUT 2 RTN	COMMON
5	NO CONN	NO CONN	+OUT 1 RTN	+5V RTN
6	NO CONN	-DC OUT	NO CONN	-DC OUT



MSC-E1 Series

40 W AC/DC Switching Power Supply Module – Medical

CoolPower
Solutions

MSC-E1-A4

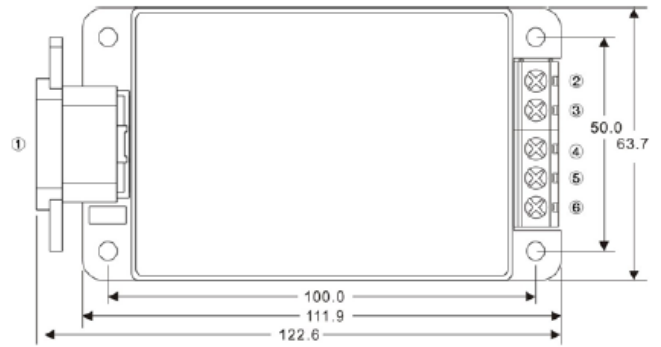

Pin	Single	Dual	5S/12S 5S24S	Triple
1	AC IN	AC IN	AC IN	AC IN
2	+DC OUT	+DC OUT	+OUT 2	+DC OUT
3	NO CONN	NO CONN	+OUT 1	+5V OUT
4	-DC OUT	COMMON	+OUT 2 RTN	COMMON
5	NO CONN	NO CONN	+OUT 1 RTN	+5V RTN
6	NO CONN	-DC OUT	NO CONN	-DC OUT



CoolPower
Solutions

MSC-E1-A5

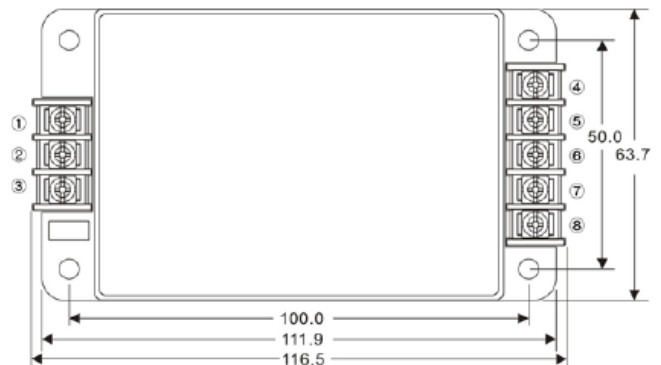

Pin	Single	Dual	5S/12S 5S24S	Triple
1	NO CONN	NO CONN	NO CONN	NO CONN
2	AC IN (L)	AC IN (L)	AC IN (L)	AC IN (L)
3	AC IN (N)	AC IN (N)	AC IN (N)	AC IN (N)
4	+DC OUT	+DC OUT	+OUT 2	+DC OUT
5	NO CONN	NO CONN	+OUT 1	+5V OUT
6	-DC OUT	COMMON	+OUT 2 RTN	COMMON
7	NO CONN	NO CONN	+OUT 1 RTN	+5V RTN
8	NO CONN	-DC OUT	NO CONN	-DC OUT

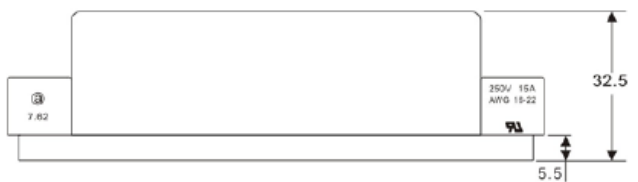

MSC-E1 Series

40 W AC/DC Switching Power Supply Module – Medical

CoolPower
Solutions

MSC-E1-A6

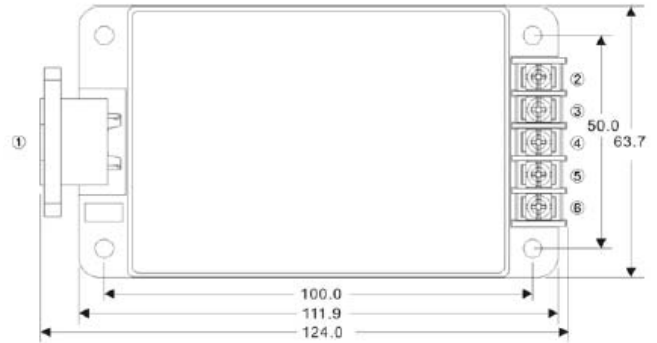

Pin	Single	Dual	5S/12S 5S24S	Triple
1	AC IN	AC IN	AC IN	AC IN
2	+DC OUT	+DC OUT	+OUT 2	+DC OUT
3	NO CONN	NO CONN	+OUT 1	+5V OUT
4	-DC OUT	COMMON	+OUT 2 RTN	COMMON
5	NO CONN	NO CONN	+OUT 1 RTN	+5V RTN
6	NO CONN	-DC OUT	NO CONN	-DC OUT

CoolPower
Solutions

MSC-E1-A7

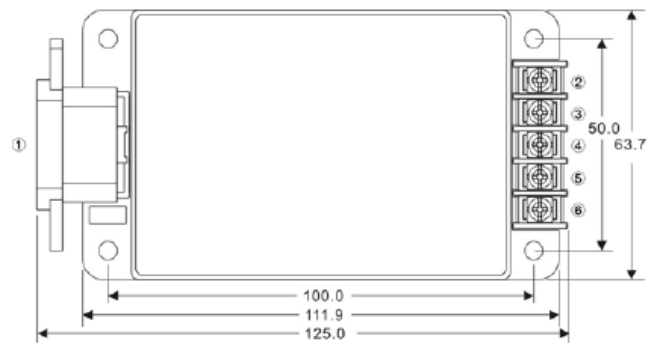

Pin	Single	Dual	5S/12S 5S24S	Triple
1	AC IN	AC IN	AC IN	AC IN
2	+DC OUT	+DC OUT	+OUT 2	+DC OUT
3	NO CONN	NO CONN	+OUT 1	+5V OUT
4	-DC OUT	COMMON	+OUT 2 RTN	COMMON
5	NO CONN	NO CONN	+OUT 1 RTN	+5V RTN
6	NO CONN	-DC OUT	NO CONN	-DC OUT